

Accident Prevention Program

On Landings, Part III

GEAR-UP LANDINGS

There are all sorts of stories about gear-up landings.

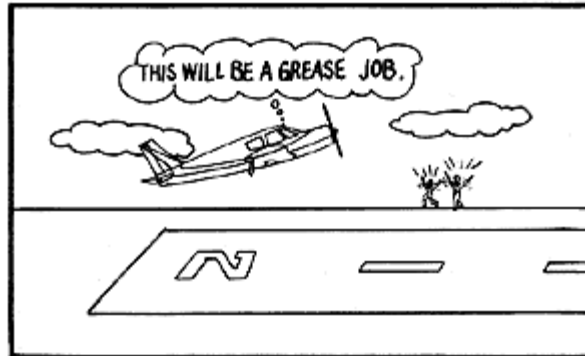

Horns, buzzers, and bells were invented to warn of gear-up approaches. But pilots sometimes ignored these horns, mistook them for stall warnings, or got so distracted they continued to forget the gear until that "sinking feeling" struck them.

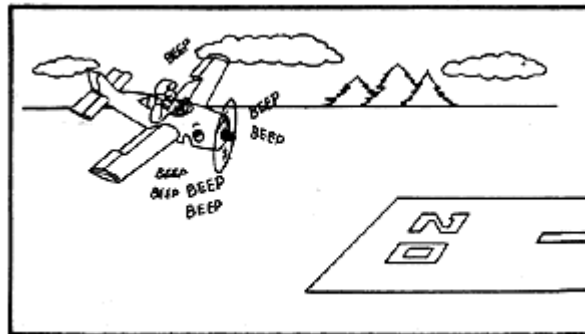

Other pilots thought that they heard the outer marker horn blaring all the way down to a gear-less touchdown!

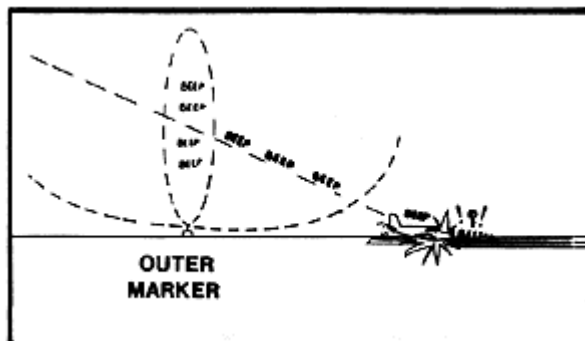

Of course, there's always the Circuit Breaker Club. Circuit Breaker Club members pull the warning horn breakers out on training flights and then forget to put them back in.

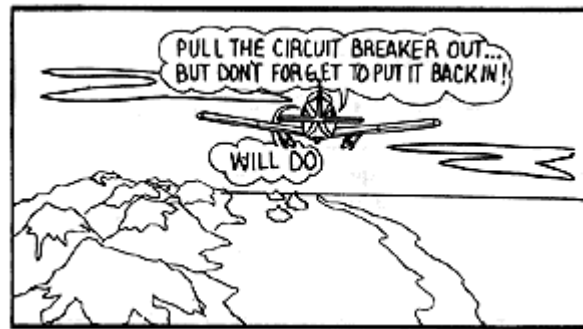

Other pilots cleverly used the landing gear as speed brakes during descent, then manipulated the handle again in the pattern-only to raise the gear by mistake.



The only way to prevent these and other landing gear mishaps is to establish a set routine and stick to it.

Always put the gear down at a standardized point in the pattern.

For instance, have the gear down and checked before you're on downwind, or, in any event, by the time you're abeam the "numbers."

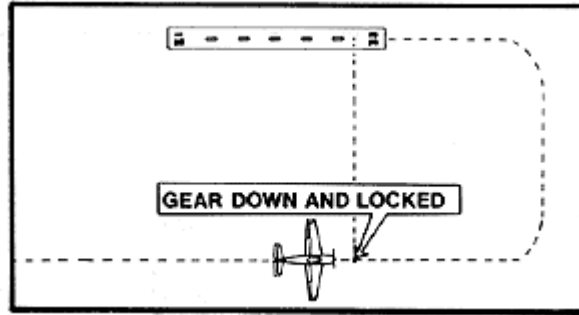

Always use your before-landing checklist and a GUMP check (Gas-Undercarriage-Mixture-Prop).

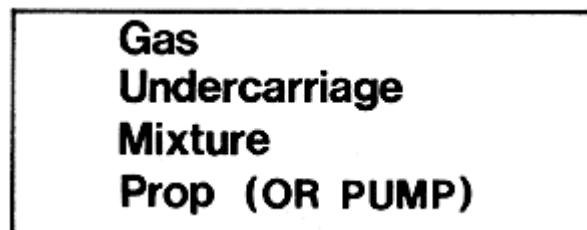

When lowering the gear, always check the gear indicator for "down and locked." Make it a habit to physically touch the gear indicators and say out loud "gear down", or "down and locked," or "three in the green."

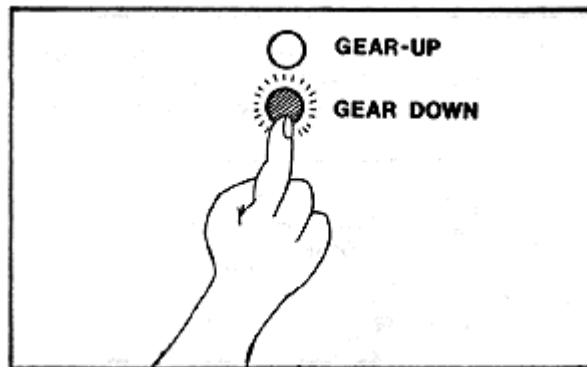

How to handle the gear while IFR?

On an ILS approach, a suggested procedure is to extend the gear when the glide slope is intercepted.

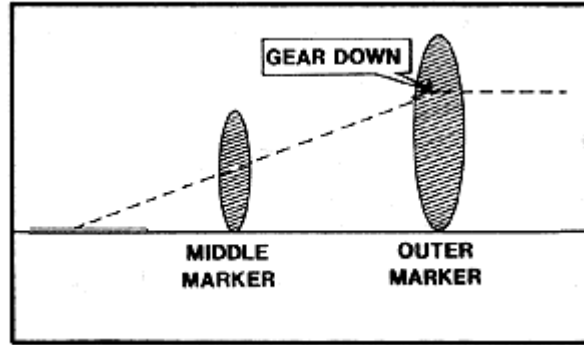

For localizer and VOR approaches, the gear should be extended when passing the final approach fix (FAF) inbound.

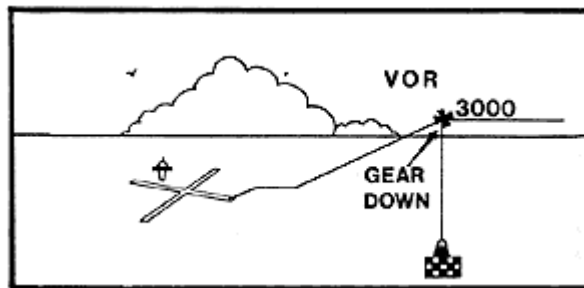

With no final approach fix, extend the gear when you roll out of the procedure turn and start your final descent.

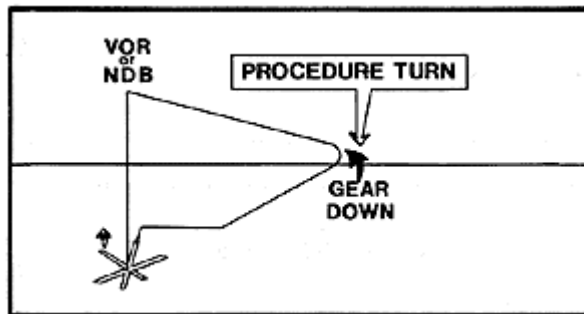

What about circling approaches? Here there are two schools of thought:

One says to put the gear down as you would while flying a normal IFR approach.

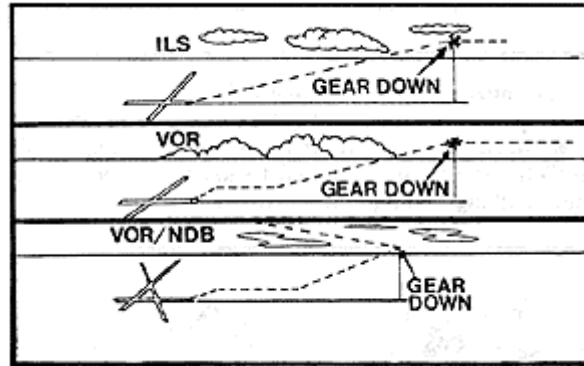

The second "school" suggests extending the gear on downwind, abeam the runway, if the runway is in sight. The advantage of this second technique is that if you lose the runway, a go-around is easier without the gear already being down. The disadvantage is that it's non-standard from your straight-in habit pattern and may cause a distraction when you are trying to keep the runway in sight. You may forget the gear. That's why a last gear check on short final is strongly advisable.

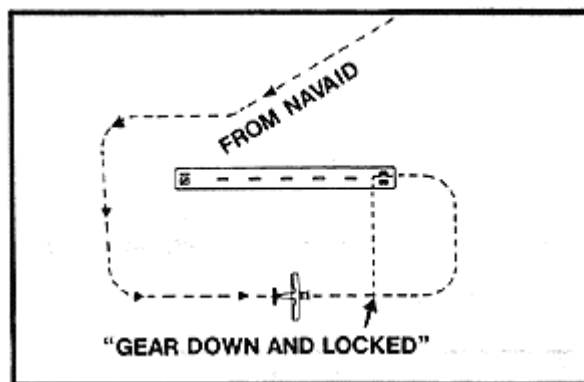

You've really got to establish your own gear procedures-and stick to them.

So, use your check list on every landing. Put the gear down at a standardized point every time, and always recheck for "three green" on short final.



Accident Prevention Program

On Landings, Part III (Continued)

WHAT ABOUT LANDING GEAR EMERGENCIES?

Always have your checklist and POH handy for ready access to emergency procedures.

Other tips? One so basic as to be seldom mentioned is an adequate fuel reserve. Don't stretch it, even in good weather. An unforeseen gear problem at the end of a long cross-country, with little fuel left, is *stressful*. Leave a cushion of time to work any last minute prob-em with the landing gear.

If you have a gear problem, climb out of the pattern, then review your emergency gear extension checklist before doing *anything*. If necessary, also refer to the POH for a description of the landing gear system. If in doubt, don't hesitate to ask for assistance by radio from an FBO with expertise in your aircraft.

As a general principle, here's the drill for emergency gear extension. Slow the aircraft, then place the gear handle or switch in the "down" position. This is the first step in just about every procedure. Some pilots flying aircraft equipped with only a "one shot" emergency gear extension system have wasted their one and only chance for a gear extension because they forgot the first simple step of putting the gear handle down.

If all else fails, you may have to resort to *special* flying techniques. One technique is to slow fly the airplane or pull an extra "G" or two by a sharp pull-up to help gravity pull the gear down. Whatever you do, don't outfly your ability or exceed the limits of the airplane.

If you think you'll be flying in freezing conditions, or takeoff from a snow or slush-covered runway, cycle the gear on departure before you climb into freezing air. Otherwise, the gear may be "frozen" in the up position when you reach your destination.

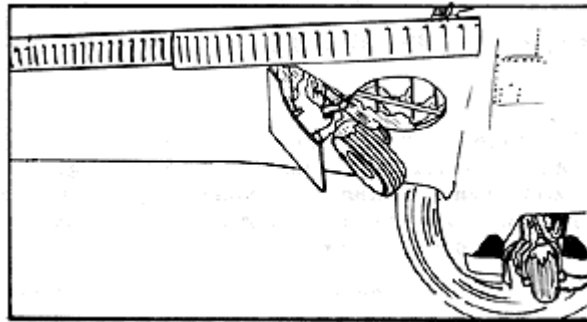

ANOTHER GEAR EMERGENCY: THE FLAT TIRE

It does happen occasionally. Some POHs deal with the problem, advising you to burn fuel out of the tank on the same side as the flat. Other procedures call for full flaps, control deflections, and some braking designed to keep the weight on the good tire.

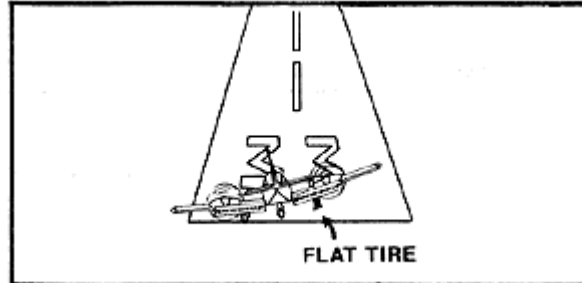

If a nosewheel is flat or the nose gear won't extend, you may want to carefully shift weight aft (within limits, of course) to help hold the nose *off* the runway until the aircraft slows. Passengers can move to rear seats if these seats are empty!

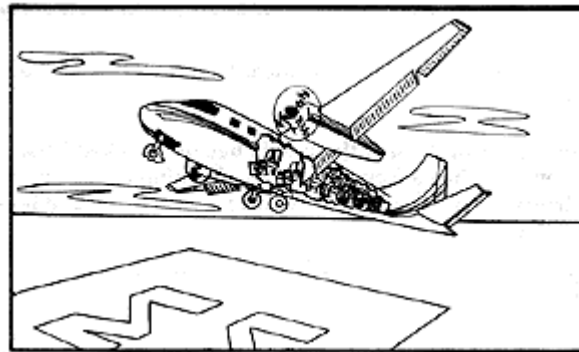

Full *down* trim can make the "up" elevator more effective on some airplanes.

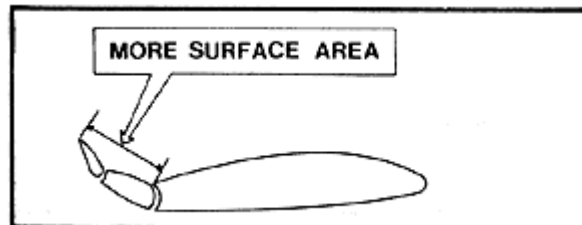

LANDING ON WET, ICY OR SNOW-COVERED RUNWAYS

Where runway friction is low or nil, aerodynamic braking becomes much more important. Use aerodynamic drag to your advantage on landing-especially when the runway is wet or icy. Simply hold the nosewheel "off" until it settles on its own.

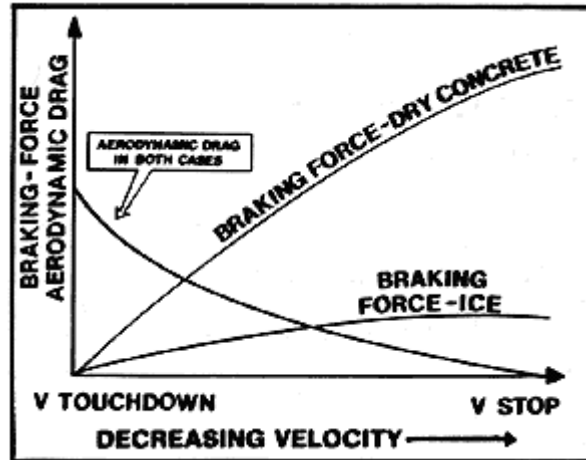

But braking isn't the only problem.



Skidding is another real hazard on a wet or icy runway.

Improper braking is the villain because locked brakes stop the wheels from rolling and braking effectiveness drops to nothing (not to mention steering effectiveness).

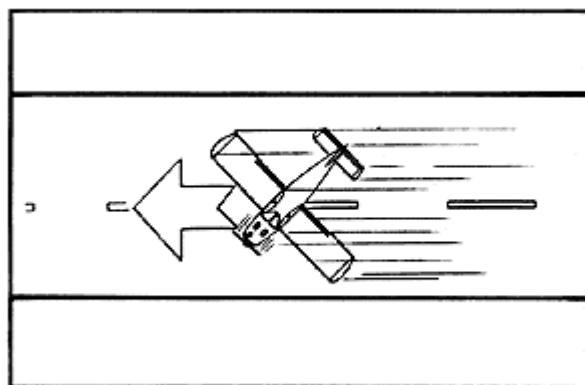

Skidding sideways is a fast ticket to blown tires or collapsed landing gear.

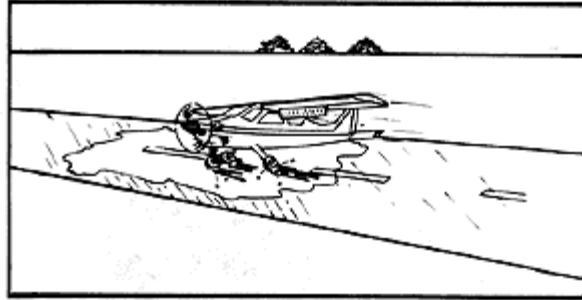

If you have to confront icy or wet conditions, have as many factors going for you as possible.

Pick a nice, long runway oriented into the wind. If unavailable, consider diverting elsewhere.

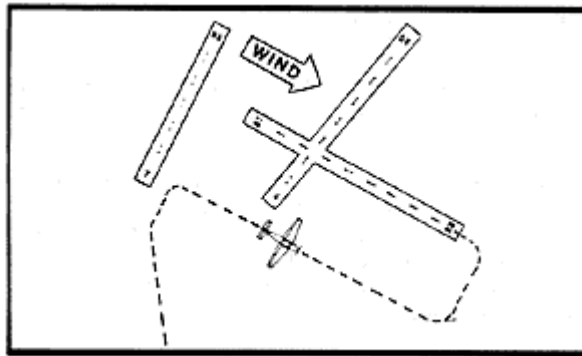

Taxiing on ice is its own headache. If you must taxi, taxi *very* slowly.



In a twin, use differential power. Also, use reversible props, if so equipped.

Another point. A clean, plowed runway with snow banks alongside at the beginning of a sunny day may become a sheet of ice when the melting snow freezes at the end of the day. This is something you might not expect in such pleasant, bright weather.



Snow presents other hazards, too.

It's difficult if not impossible to judge snow depth on final. Accident reports bear this out in spades. And snow of any depth obscures runway markings.

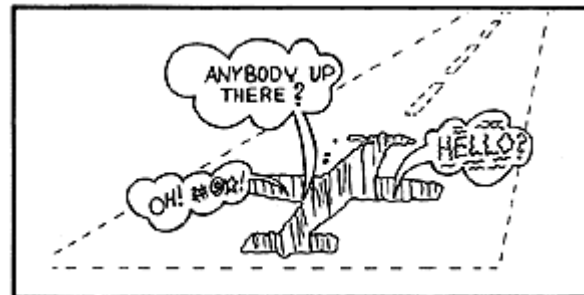

Continued plowing raises snow banks on either side of the runway—a definite hazard. The more plowing, the closer they get.

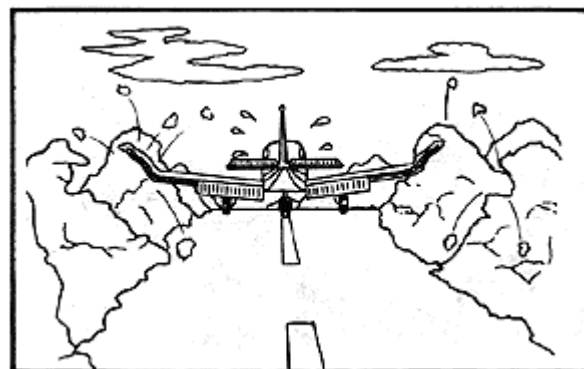

Blowing snow can cause depth perception problems. Sometimes, a "white out" results, like landing inside a light bulb. You can miss the runway entirely.

Landing on an icy or snow-covered runway requires advance planning. Check destination runway conditions such as field condition reports, NOTAMS, and/or call to check with local observers. And never expect conditions to remain constant, they do change rapidly in winter. Get updated weather en route and always have an alternate ready. Finally, check UNICOM for an update before landing.

A word of caution, however, on pilot braking reports-use discretion in interpreting reports of "good" or "poor" braking. These subjective classifications depend on aircraft type and pilot experience, as well as wind and weather conditions at the time of the report. And in some instances, pilots or FBOs are unwilling to give runway braking reports.

Again, when flying in winter, caution is the watch-word. Always leave yourself an out, and be sure to carry adequate fuel reserves.

Accident Prevention Program

On Landings, Part III (Continued)

WATER ON THE RUNWAY AND DYNAMIC HYDROPLANING

Spring, summer, winter or fall, anytime is time for water on the runway.

When the runway's wet you may be confronted with dynamic hydroplaning. Dynamic hydroplaning is a condition in which the airplane rides on a sheet of water rather than on the runway's surface. Because hydroplaning wheels are not touching the runway, braking and directional control are almost nil.

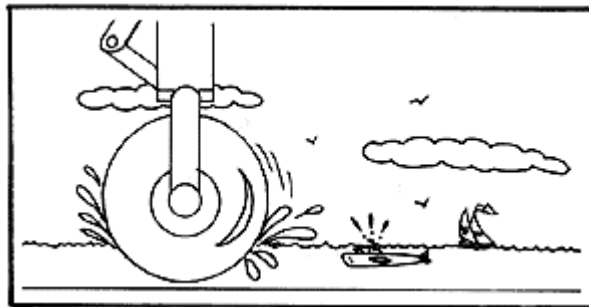

You are literally "surfing..."



THREE TYPES OF HYDROPLANING

There are actually three types of hydroplaning:

- Dynamic-where the airplane rides on standing water;
- Viscous-where a film of moisture covers the painted or rubber-coated portion of the runway; and,
- Reverted, or melted rubber-where locked tires on a wet runway can cause heat so intense that the aircraft is actually riding on a mixture of steam and melted rubber.

For now, we'll concentrate only on dynamic hydroplaning...

To help minimize dynamic hydroplaning, some runways are grooved to help drain off water. But most runways are not.

Tire pressure is a factor in dynamic hydroplaning. By this simple formula you can calculate the *minimum* speed, in knots, at which hydroplaning will begin. In plain language, the minimum hydroplaning speed is determined by multiplying the square root of the main gear tire pressure, in PSI, by nine.

MINIMUM DYNAMIC HYDROPLANING SPEED (ROUNDED OFF) =
$9 \times \sqrt{\text{TIRE PRESSURE (IN PSI)}}$

For example, if your main gear tire pressure is at 36 pounds per square inch, you would begin hydroplaning at 54 knots.

$\sqrt{36} = 6$
$9 \times 6 = 54 \text{ KNOTS}$

Landing at higher than recommended touchdown speeds will expose you to a greater potential for hydroplaning. And once hydroplaning starts, it can continue well below the minimum, initial hydroplaning speed.

When the runway is wet, be prepared for hydroplaning and opt for a suitable runway most aligned with the wind. Landing into the wind gives you the best chance for directional control-but don't count on it. If you hydroplane, make no abrupt control movements. Your brakes will be completely useless-so don't use them. Use aerodynamic braking to your fullest advantage.

In summary, think about runway braking problems well before you land.

LANDING AT NIGHT

Night landings have a special element of risk. Part of the reason is that pilots often don't maintain their night flying proficiency. But don't kid yourself-night flying can be as tough as flying on instruments.

Get some dual night flying with an instructor periodically, and prepare for the unexpected. Shoot some landings without panel lights and, where permitted, without landing lights.

At night, traffic patterns must be flown with extra care. Allow plenty of time to do your pre-landing checklist *before* entering the pattern.



In the pattern, maintain the recommended speeds-don't exceed them. Give yourself plenty of time to prepare for the approach and landing.

A long, low final is to be avoided at all costs and especially at night. The presence of unseen obstacles around the airport is a prime reason to always check flight information publications for airport details before you launch. Know where those obstacles are *before*, not after.



On approach, make sure your glide path is high enough to stay well clear of all obstacles- not just the ones you can see.

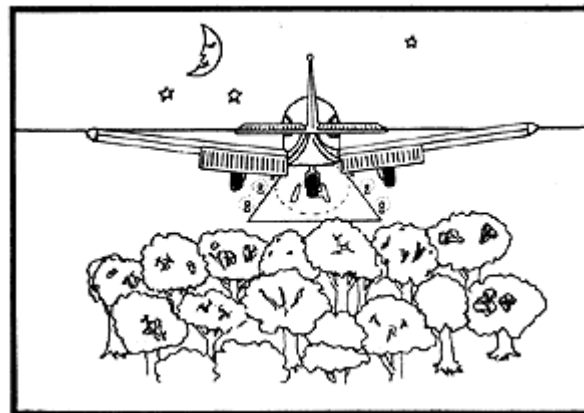

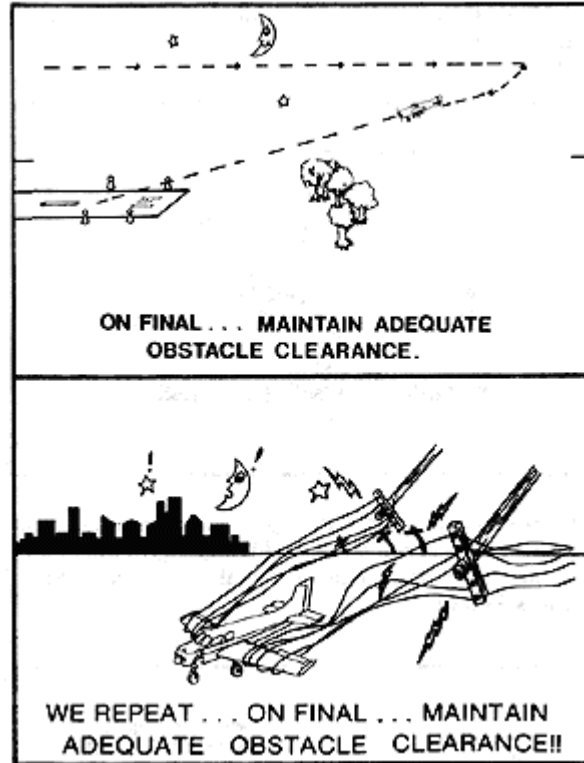

This is also the time to be sure your directional gyro is aligned with the magnetic compass. It will help you locate the runway you'll want to use.

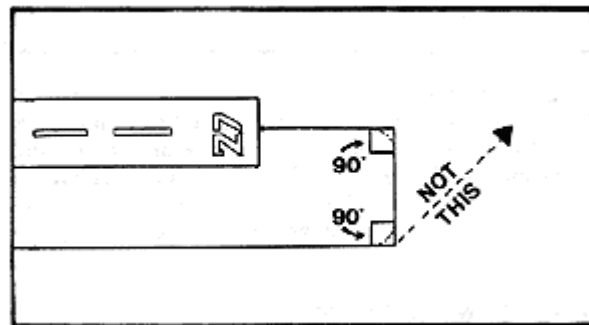

As another aid, set the heading bug on the DG (or heading indicator) if so equipped. The "bug" helps in flying a square pattern at night.

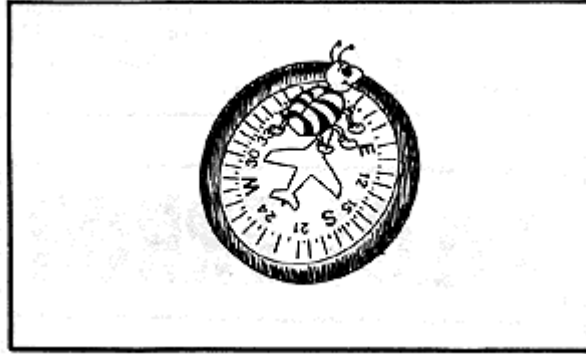

For Pete's sake, set your altimeter. Remember, a one inch decrease in barometric pressure means your altimeter reading is about one thousand feet higher than your actual altitude.

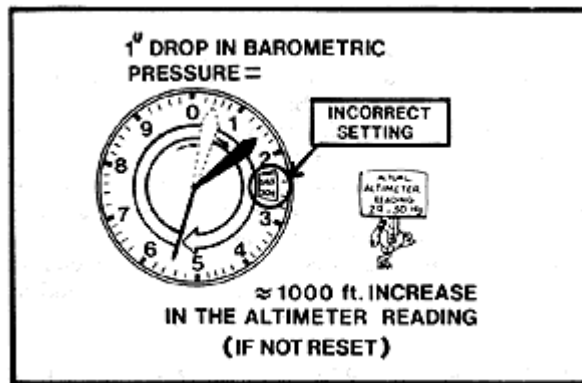

On final, take advantage of VASI guidance where available. Never allow a "low" indication to appear at night. Get back up to your glide path immediately or take it around and try again.

With ATC permission, you can also make use of an ILS to guide you to your landing runway at night.

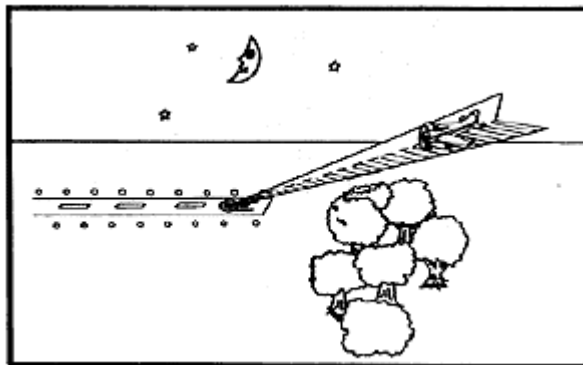

If runway lights become fuzzy on final, beware. You may be seeing the effects of ground fog which can lead to "suddenly" reduced visibility as you near the runway for

touchdown. Fog can form in minutes, obscuring all or part of any runway. An alternate airport may be your best bet.

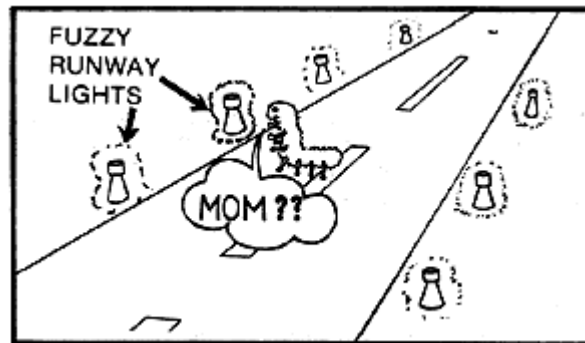

"Atmospherics" can change colors, light intensities, even depth perception. Even when "atmospherics" are not a problem, optical illusions can be.

A lighted area may be mistaken for a runway; one airport may be mistaken for another, resulting in landing at the wrong facility. Landings on roads and parking lots are not unheard of when lighting patterns create confusion.

To cut costs, some airport lighting is now radio controlled. Be sure you know how to use them; know the specific instructions for the runway lighting installed where you're landing. Flight information publications have the data, including frequencies and procedures to activate these lighting systems as well as how to raise or lower the light intensity. By the way, many systems turn themselves off after 15 minutes. Don't be caught on short final when the lights go out. If you are caught, go-around, turn the lights back on, and try again.

Never attempt a landing at an unlighted airport, no matter how well you think you know it. If in doubt about lighting at your destination, don't be embarrassed. Call Flight Service.



At a tower controlled airport, you may also have the option of asking for the raising or lowering of runway light intensity, if needed.

You can also ask them to "kill the rabbit," that is, extinguish the sequential strobe approach lights if they become distracting, which they often do when you're close to the runway.

An easy way to enhance your ability to see outside obstacles is to dim interior cockpit lighting. Know the color coding: "aviation red" lighting or white strobes mean obstacles to air navigation.

More about lights-flashlights. If you're caught dead without one, it's pilot error. In fact, you should carry a couple. They're awfully easy to lose down under a seat somewhere, especially when you need one. An old naval aviator's trick is to keep one around the neck on a lanyard.

Flashlights should be in working order. Experienced pilots carry spare bulbs and batteries.

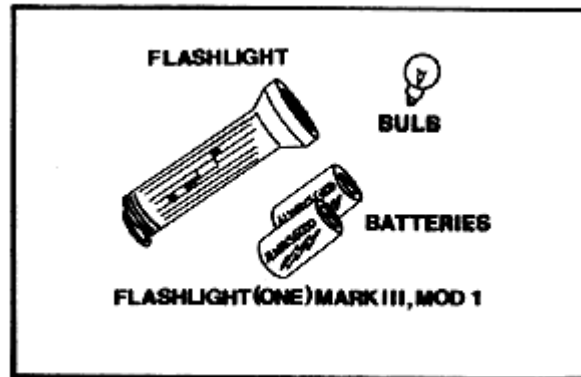

Also important at night is a spare pair of glasses. Your eyes work harder at night and it's going to be tough if you lose a contact lens or break your only pair of glasses in flight.

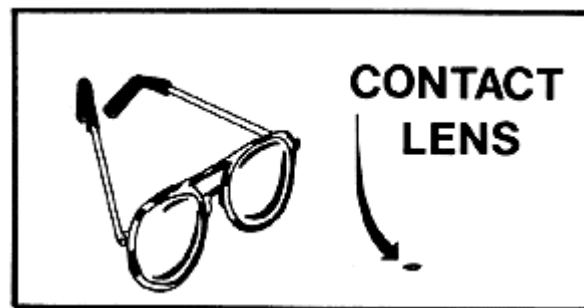

At an airport that's not very busy, it's often best to "drag the field" at fifty to one hundred feet on the first pass to check for obstructions and animals at night. Runways hold the day's heat and animals love to congregate there as the cool night progresses. Also, runways are favorite places for clandestine drag racing.

THE HUMAN ELEMENT

When it comes right down to it, most accidents, including landing phase accidents, are the result of failure in the human element. More specifically, it is often a failure in the decision-making process.

Most accidents end up as attributed to "pilot error." But that refers to a whole gamut of problems like stress overload, or being on a mental holiday, or pushing oneself beyond rational limits.

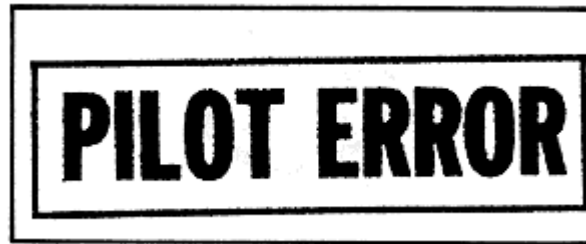

Facts show that some of the worst pilot error accidents happen at night. Perhaps you're so hungry you can hear your stomach growl or you're so tired your eyes burn and your muscles ache. Then there's always the ever-popular "get-home-itis." They can all lead you to rationalize your "go/no-go decision" and lead you to a landing accident, the kind of accident that occurs when you're the most tired.

A FINAL WORD

Landing phase accidents account for roughly half of all flying accidents each year. And it's ironic that they're always the same kinds of accidents. What can you do?

Review the basics-get that knowledge. Sharpen your flying skills-shoot some landings. Bring your proficiency up to snuff, and keep it there.

Above all, recognize that you, as pilot-in-command, are the weakest link in the overall man-machine system, especially when you're under stress. Fly relaxed. It will help you make better decisions.

Note: The suggestions and "rules" given in this handout are intended to be helpful aids only and are not intended to replace or supersede the recommendations of the aircraft manufacturer.